

SURGERY

BODY CAVITIES PUNCTURE SET

One-step method drainage set	2
Two-step method drainage set	3

VASCULAR SURGERY

Embolectomy catheters fogarty's, single lumen	4
Embolectomy catheters fogarty's, double lumen	5
Aortic catheter	5
Vessel irrigation catheter	6

SURGICAL FIELD ASPIRATION

Surgical field aspiration catheter with or without suction control	7
Surgical field aspiration catheter	7
Surgical field aspiration extender	8
Surgical wounds aspiration catheter (ileostomy)	8

OTHER PRODUCTS

Redon - type aspiration catheter	9
Bottle for long-lasting wound aspiration	9
Ventral drain	10
Drain tubing	10
Thorax drainage catheter without trocar	11
Thorax drainage catheter with trocar	11

GASTROENTEROLOGY

GASTROENTEROLOGY

Endoscopic balloon dilation catheter Troyca for esophageal, pyloric and colonic	12
Tracheal and esophageal stent with delivery system Tor	14
Extraction and occlusion catheter	15
Catheter for bile ducts' plasty	15
Dilating catheter soehender type percutaneous method	16
Dilating catheter soehender type	17
Oral biliary ducts drainage set	17
Biliary prosthesis insertion with straight type prosthesis	18
Straight type prosthesis	19
Greenen type prosthesis	19
Pigtail type prosthesis	20
Zimmon type prosthesis	20
Duodenal tube	21
Gastric tube	22
Rectal tube	23
Gastric catheter	24
Intestinal stents catheter triple channel catheters	24

ONE-STEP METHOD DRAINAGE SET

**Set components:**

straight or pigtail type catheter
two pieces needle
band clip
collar

Reference:	Catheter size / length	Two-pieces needle size
OSD6F	6F/26 cm PIGTAIL	18G
OSD6FP	6F/26 cm STRAIGHT	18G
OSD9F	9F/26 cm PIGTAIL	15G
OSD9FP	9F/26 cm STRAIGHT	15G
OSD12FP	12F/26 cm PIGTAIL	15G
OSD12F	12F/26 cm STRAIGHT	15G
OSD14F	14F/26 cm STRAIGHT	15G
OSD14FP	14F/26 cm PIGTAIL	15G
OSD16F	16F/26 cm STRAIGHT	15G

Straight or pigtail catheter is well visible in X-rays. Simple one-step system eliminates the need of using needle, guide wire, or drain placement radiological control. Safe, atraumatic drain prevents wound perforation. It is used for fluid drainage from the pleura, peritoneum, and cysts. Drains 9F and bigger allow for abscess drainage.

When ordering use Ref. Number, e.g.: OSD16F.

TWO-STEP METHOD DRAINAGE SET

Set components:

- pigtail or straight type catheter
- needle 18G x 7 cm
- two pieces needle
- guide wire thin, flexible spring .035" x 60 cm
- dilatator
- one way stopcock
- connecting tube
- band clip, collar



Reference:	Catheter size / length	Two-pieces needle size	Dilatator size / length
ZPDA6F	6F/26 cm PIGTAIL	18G	6F/18 cm
ZPDA6FP	6F/26 cm STRAIGHT	18G	6F/18 cm
ZPDA9F	9F/26 cm PIGTAIL	15G	9F/18 cm
ZPDA9FP	9F/26 cm STRAIGHT	15G	9F/18 cm
ZPDA12FP	12F/26 cm PIGTAIL	15G	12F/18 cm
ZPDA12F	12F/26 cm STRAIGHT	15G	12F/18 cm
ZPDA14F	14F/26 cm STRAIGHT	15G	14F/18 cm
ZPDA16F	16F/26 cm STRAIGHT	15G	16F/18 cm

The catheter is made of biologically neutral material, well visible in X-rays. The curved tip prevents catheter displacement inside the tissues. Its smooth surface, thin walls, large side holes and adequately selected type of plastic material make drainage effective for a prolonged period of time. A one-way stopcock and extender allow attachment to a standard urine collection bag.

When ordering use Ref. Number, e.g.: ZPDA12F.

EMBOLECTOMY CATHETERS

Fogarty's, single lumen



The embolectomy catheters are used for the safe and convenient removal of thromboembolic material from arteries and veins. The catheters for embolectomy are made of biologically indifferent material. Their elasticity is matched to their size. The balloon is made of latex. It withstands the pressure indispensable for achieving of satisfactory effect. A silk thread is an additional fastening of the balloon. Each size has the colour corresponding to the international colour code. Marks are made at intervals of 10 cm. Stainless steel mandrin facilitates catheter introduction into the vessel. The soft spherical tip reduces to a minimum the probability of vessel wall perforation. The other end of the catheter has a Luer-Lock attachment. The catheter diameter and balloon volume are given on each catheter. Sterilization is with gamma radiation. Single lumen Fogarty catheters can be used for removal of concrements from bile ducts.

Reference:	Catheter size / length	Tube colour	Diameter of filled balloon	Balloon volume filled with liquid
EFB2F40	2F / 40 cm	white	5 mm	0.15 ml
EFB2F60	2F / 60 cm	white	5 mm	0.15 ml
EFB3F40	3F / 40 cm	green	6 mm	0.20 ml
EFB3F80	3F / 80 cm	green	6 mm	0.20 ml
EFB4F40	4F / 40 cm	red	8 mm	0.70 ml
EFB4F80	4F / 80 cm	red	8 mm	0.70 ml
EFB5F40	5F / 40 cm	white	10 mm	1.50 ml
EFB5F80	5F / 80 cm	white	10 mm	1.50 ml
EFB6F40	6F / 40 cm	blue	12 mm	2.00 ml
EFB6F80	6F / 80 cm	blue	12 mm	2.00 ml
EFB7F40	7F / 40 cm	yellow	14 mm	2.50 ml
EFB7F80	7F / 80 cm	yellow	14 mm	2.50 ml
EFB8F40	8F / 40 cm	brown	16 mm	3.50 ml
EFB8F80	8F / 80 cm	brown	16 mm	3.50 ml
EFB10F40	10F / 40 cm	grey	20 mm	4.50 ml
EFB10F80	10F / 80 cm	grey	20 mm	4.50 ml

When ordering use Ref. Number, e.g.: EFB5F40.

EMBOLECTOMY CATHETERS

Fogarty's, double lumen

The embolectomy catheters are used for the safe and convenient removal of thromboembolic material from arteries and veins. The catheters for embolectomy are made of biologically indifferent material. Their elasticity is matched to their size. The balloon is made of latex. It withstands the pressure indispensable for achieving of satisfactory effect. A silk thread is an additional fastening of the balloon. Each size has the colour corresponding to the international colour code. Marks are made at intervals of 10 cm. Stainless steel mandrin facilitates catheter introduction into the vessel. The soft spherical tip reduces to a minimum the probability of vessel wall perforation. The other end of the catheter has a Luer-Lock hub. The catheter diameter and balloon volume are given on each catheter. Sterilization is with gamma radiation. Double lumen Fogarty catheters can be used for removal of concretions from bile ducts. Balloon made of latex, silk thread suture to increase connection strength with catheter. Protection against UV radiation.

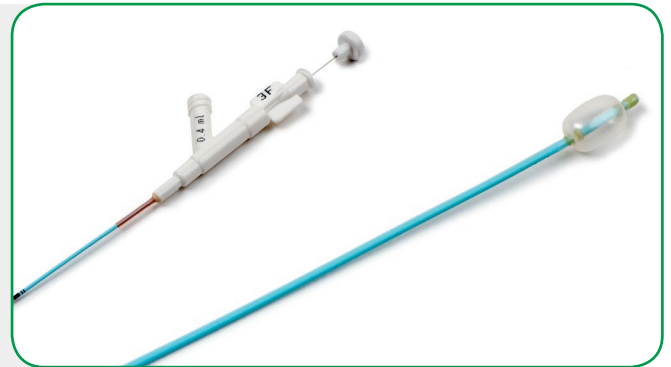

Reference:	Catheter size / length	Diameter of filled balloon	Balloon volume filled with liquid	Balloon volume filled with air
EFBD5F80	5F / 80 cm	10 mm	0.6 ml	2 cm ³
EFBD6F80	6F / 80 cm	12 mm	0.8 ml	3 cm ³
EFBD7F80	7F / 80 cm	14 mm	1.5 ml	4 cm ³

When ordering use Ref. Number, e.g.: EFBD7F80.

AORTIC CATHETER

Used for rinsing during organ transplants. The triple channel aortic catheter has two balloons of 20 ml or 35 ml volume each. The catheter between the balloons is perforated. The proximal and distal catheter tips are marked.



Reference:	Catheter size	Balloon volume filled with liquid	Catheter length
KA16F90	16F	20 ml	90 cm
KA22F90	22F	35 ml	90 cm

When ordering use Ref. Number, e.g.: KA16F90.

VESSEL IRRIGATION CATHETER

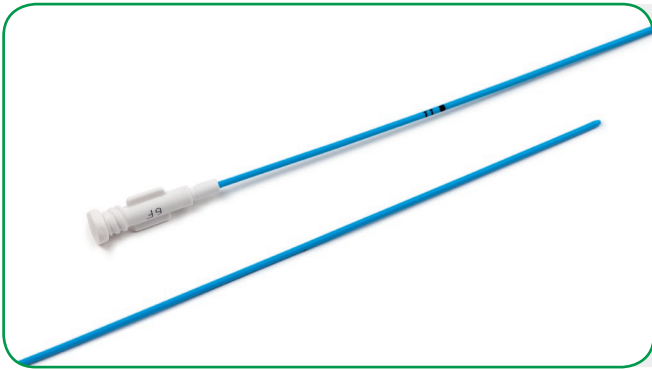

The catheter is made of thermoplastic (medical grade) PVC.
Each size marked with a different colour pursuant to international standards.

Reference:	Catheter size / length	Tube colour
PNK3F80	3F / 80 cm	green
PNK4F80	4F / 80 cm	red
PNK5F80	5F / 80 cm	white
PNK6F80	6F / 80 cm	blue
PNK7F80	7F / 80 cm	yellow
PNK8F80	8F / 80 cm	brown
PNK10F80	10F / 80 cm	grey

When ordering use Ref. Number, e.g.: PNK7F80.

SURGICAL FIELD ASPIRATION CATHETER

with or without suction control

Operation field suctioning catheter allows the suctioning of blood, flushing solutions, and discharges from the operation field. A catheter with adequate distal tip (curved or straight tip) can be selected depending on suctioning place location. Clear to allow visual examination of drainage.

Catheter available in configuration with suction strength control or without it.

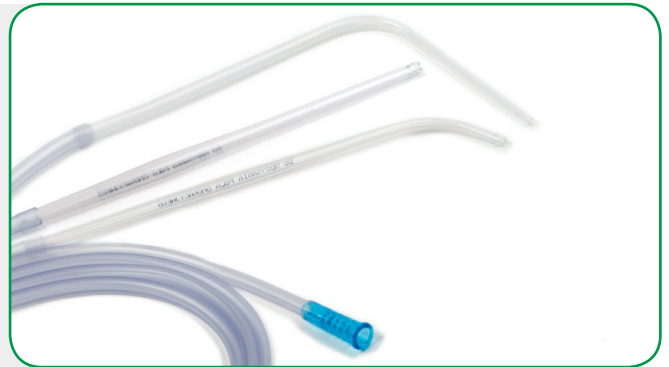

Reference:
catheter length 200 cm

KOPO200
KOPOOB200
KOPO200P
KOPOOB200P
KOPO200C
KOPOOB200C

Reference:
catheter length 300 cm

KOPO300
KOPOOB300
KOPO300P
KOPOOB300P
KOPO300C
KOPOOB300C

Catheter with curved tip (27F)
Catheter with suction strength controlling hole (curved tip 27F)
Catheter with straight tip (27F)
Catheter with suction strength controlling hole (straight tip 27F)
Catheter with thin tip (22F)
Catheter with suction strength controlling hole (thin tip, 22F)

When ordering use Ref. Number, e.g.: KOPOOB200P.

SURGICAL FIELD ASPIRATION CATHETER

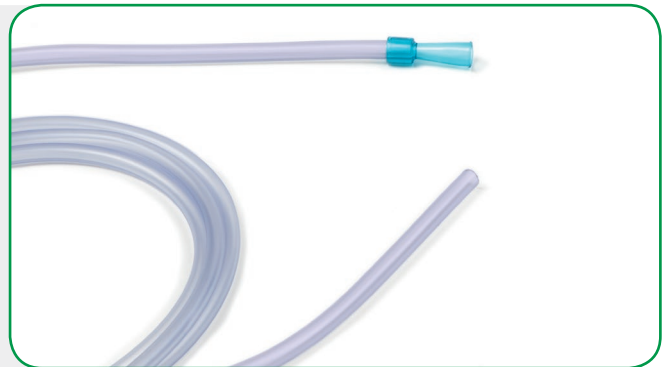

Reference:

DOP0200
DOP0300

When ordering use Ref. Number, e.g.: DOP0300.

SURGICAL FIELD ASPIRATION EXTENDER

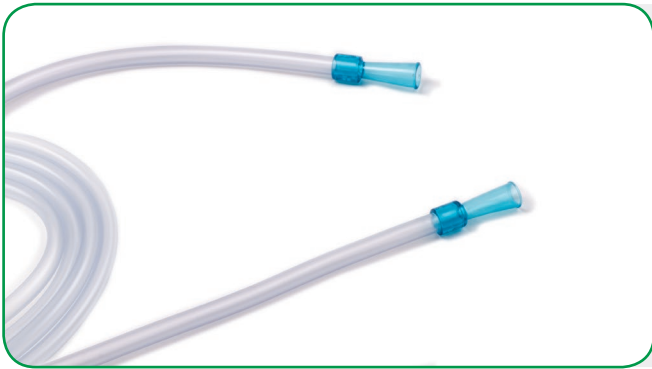
**Reference:**

POPO200

POPO300

When ordering use Ref. Number, e.g.: POPO300.

SURGICAL WOUNDS ASPIRATION CATHETER (ILEOSTOMY)



The surgical aspiration catheter (ileostomy) is used during abdominal surgery. It allows the suction of intestinal contents at a long distance. Length 200 cm, perforated on 120 cm. Size 21F.

The catheter is made of thermoplastic (medical grade) PVC.

Reference:

KOR021F200

When ordering use Ref. Number, e.g.: KOR021F200.

REDON - TYPE ASPIRATION CATHETER

Used for drainage. Conventional perforation eyes (Redon type).
Made of PCV, medical grade.

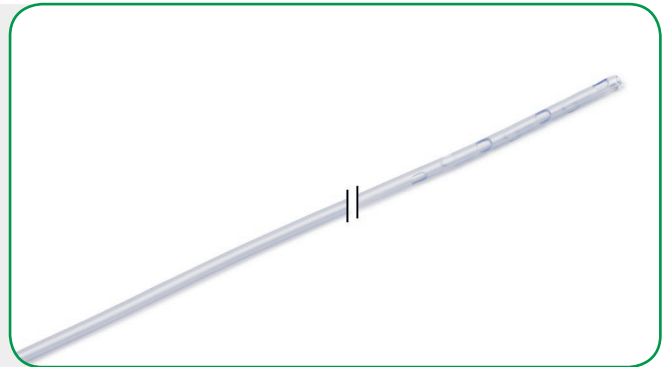

Reference:

KOR6F50
KOR8F50
KOR10F70
KOR12F70
KOR14F70
KOR16F70
KOR18F70
KOR20F70
KOR22F70
KOR24F70
KOR26F70
KOR28F70
KOR30F70
KOR32F70

Catheter size / length

6F / 50 cm
8F / 50 cm
10F / 70 cm
12F / 70 cm
14F / 70 cm
16F / 70 cm
18F / 70 cm
20F / 70 cm
22F / 70 cm
24F / 70 cm
26F / 70 cm
28F / 70 cm
30F / 70 cm
32F / 70 cm

When ordering use Ref. Number, e.g.: KOR24F70.

BOTTLE FOR LONG-LASTING WOUND ASPIRATION

contains 250 ml, 400 ml

Bottle for prolonged time wound suctioning used in surgery wounds treatment. Available in 250 ml and 400 ml configurations allowing attachment to wide range of drain tubing from 6F to 32F. Tip adapted to different suction drains diameters.
Made of polyethylene.



Reference:

BS250
BS400

When ordering use Ref. Number, e.g.: BS400.

VENTRAL DRAIN

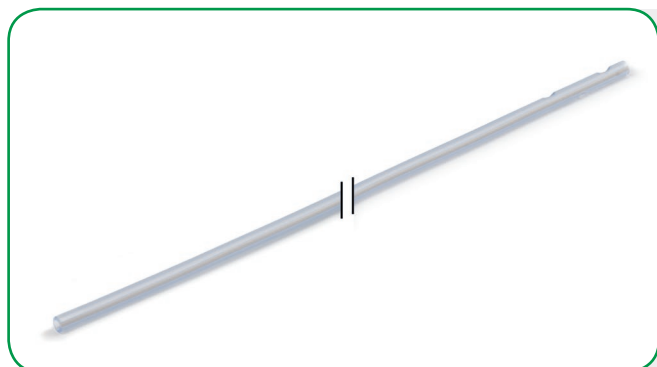

The ventral drains are made of siliconed high-quality soft plastic material.

Two versions are available:

- * with side holes - sterile / length 30 or 40 cm /
- * without side holes - sterile / length 30 or 40 cm /

Reference: without side holes

DB20F30
DB22F30
DB24F30
DB26F30
DB28F30
DB30F30
DB32F30
DB34F30
DB36F30
DB20F40
DB22F40
DB24F40
DB26F40
DB28F40
DB30F40
DB32F40
DB34F40
DB36F40

Reference: with side holes

DB20F30OB3
DB22F30OB3
DB24F30OB3
DB26F30OB3
DB28F30OB3
DB30F30OB3
DB32F30OB3
DB34F30OB3
DB36F30OB3
DB20F40OB3
DB22F40OB3
DB24F40OB3
DB26F40OB3
DB28F40OB3
DB30F40OB3
DB32F40OB3
DB34F40OB3
DB36F40OB3

Catheter size / length

20F / 30 cm
22F / 30 cm
24F / 30 cm
26F / 30 cm
28F / 30 cm
30F / 30 cm
32F / 30 cm
34F / 30 cm
36F / 30 cm
20F / 40 cm
22F / 40 cm
24F / 40 cm
26F / 40 cm
28F / 40 cm
30F / 40 cm
32F / 40 cm
34F / 40 cm
36F / 40 cm

When ordering use Ref. Number, e.g.:

DB32F40

DB30F40OB3 - with side holes

DRAIN TUBING



Ext. diameter: 1 mm to 12 mm
Drain tubing: sterile or non-sterile

Reference:

D

When ordering use Ref. Number, e.g.: D.

THORAX DRAINAGE CATHETER without trocar

The thorax drainage catheter is used for gas or liquid aspiration from thoracic cavity. The X-ray line ensure position control. Lateral eyes permit effective drainage. The thorax drainage catheter is made of high-quality PVC, medical grade, having the required softness and elasticity.



Reference:

DKP16F50
DKP18F50
DKP20F50
DKP22F50
DKP24F50
DKP26F50
DKP28F50
DKP30F50
DKP32F50
DKP34F50
DKP36F50

Catheter size / length

16F / 50 cm
18F / 50 cm
20F / 50 cm
22F / 50 cm
24F / 50 cm
26F / 50 cm
28F / 50 cm
30F / 50 cm
32F / 50 cm
34F / 50 cm
36F / 50 cm

When ordering use Ref. Number, e.g.: DKP32F50

THORAX DRAINAGE CATHETER with trocar

The thorax drainage catheter is used for gas or liquid aspiration from thoracic cavity. The X-ray line ensure position control. Lateral eyes permit effective drainage. The thorax drainage catheter is made of high-quality PVC, medical grade, having the required softness and elasticity.



Reference:

KDKPT10F
KDKPT16F
KDKPT24F
KDKPT28F
KDKPT32F

Catheter size

10F
16F
24F
28F
32F

Trocar size / length

10F / 25 cm
16F / 25 cm
24F / 40 cm
28F / 40 cm
32F / 40 cm

When ordering use Ref. Number, e.g.: KDKPT24F.

ENDOSCOPIC BALLOON DILATION CATHETER *TROYCA*

for esophageal, pyloric and colonic
FIXED WIRE TYPE & GUIDE WIRE TYPE



- One balloon - three different diameters at three separate pressures
- Compatible channel of endoscope 2.8 mm or larger
- Very good visibility in fluoroscopy
- Very short deflation time

FIXED WIRE TYPE

Reference:	Balloon diameter	Balloon length	Pressure	Catheter length
EBRS68X80180	6 mm	80 mm	3 atm	180 cm
	7 mm	80 mm	6 atm	180 cm
	8 mm	80 mm	9 atm	180 cm
EBRS810X80180	8 mm	80 mm	3 atm	180 cm
	9 mm	80 mm	5.5 atm	180 cm
	10 mm	80 mm	8 atm	180 cm
EBRS1012X80180	10 mm	80 mm	3 atm	180 cm
	11 mm	80 mm	5 atm	180 cm
	12 mm	80 mm	7 atm	180 cm
EBRS1215X80180	12 mm	80 mm	3 atm	180 cm
	13 mm	80 mm	4.5 atm	180 cm
	15 mm	80 mm	7.5 atm	180 cm
EBRS1518X80180	15 mm	80 mm	3 atm	180 cm
	16.5 mm	80 mm	4.5 atm	180 cm
	18 mm	80 mm	6.5 atm	180 cm
EBRS1820X80180	18 mm	80 mm	3 atm	180 cm
	19 mm	80 mm	4.5 atm	180 cm
	20 mm	80 mm	5.5 atm	180 cm

When ordering use Ref. Number, e.g.: EBRS1820X80180.

GUIDE WIRE TYPE

Reference:	Balloon diameter	Balloon length	Pressure	Catheter length	Use with guide wire
EBRP68X5535240	6 mm	55 mm	3 atm	240 cm	.035"
	7 mm	55 mm	6 atm	240 cm	.035"
	8 mm	55 mm	9 atm	240 cm	.035"
EBRP810X5535240	8 mm	55 mm	3 atm	240 cm	.035"
	9 mm	55 mm	5.5 atm	240 cm	.035"
	10 mm	55 mm	8 atm	240 cm	.035"
EBRP1012X5535240	10 mm	55 mm	3 atm	240 cm	.035"
	11 mm	55 mm	5 atm	240 cm	.035"
	12 mm	55 mm	7 atm	240 cm	.035"
EBRP1215X5535240	12 mm	55 mm	3 atm	240 cm	.035"
	13 mm	55 mm	4.5 atm	240 cm	.035"
	15 mm	55 mm	7.5 atm	240 cm	.035"
EBRP1518X5535240	15 mm	55 mm	3 atm	240 cm	.035"
	16.5 mm	55 mm	4.5 atm	240 cm	.035"
	18 mm	55 mm	6.5 atm	240 cm	.035"
EBRP1820X5535240	18 mm	55 mm	3 atm	240 cm	.035"
	19 mm	55 mm	4.5 atm	240 cm	.035"
	20 mm	55 mm	5.5 atm	240 cm	.035"

When ordering use Ref. Number, e.g.: EBRP1820X5535240.

We recommend specially designed PTFE coated guide wire which ensures safe and easy use of the endoscopic balloon catheter. The guide wire is available for all endoscopic balloon catheter sizes.

Reference:	Guide wire diameter	Guide wire length
P35300TE	.035"	300 cm

TRACHEAL AND ESOPHAGEAL STENT TOR with delivery system

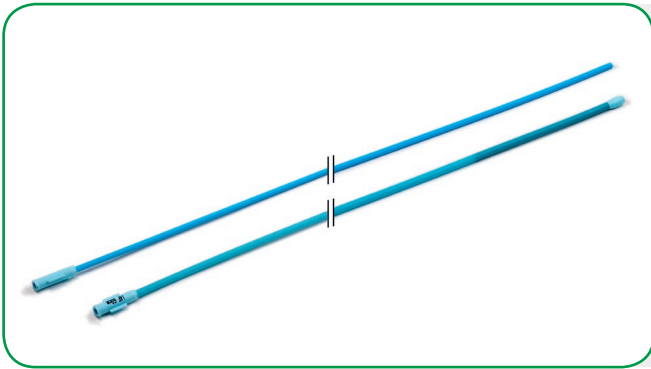

Tracheal and esophageal Tor stent is made of nitinol, which is material of high biocompatibility.

Tor stent with the delivery system provides high efficiency and comfort of application during an attempt to restore patency of highly stenotic trachea, bronchi or esophagus.

Thanks to its perfect elasticity the stent perfectly matches the shape of the trachea and esophagus.

A special construction of the stent protects against migration.

The delivery system is characterised by high elasticity.

Atraumatic endings of the system minimise the risk of damage during the procedure.

Technical information

Stent made of nitinol.

Very high radial force of the stent.

Rounded endings of the stent which efficiently protect the walls of the trachea and esophagus against damage.

Very good stent radiopacity - platinum markers on the stent endings which allow for precise implantation.

Atraumatic ending of the delivery system.

Size of the delivery system - 14F.

Reference:	Nominal stent diameter	Nominal stent length	Total system length	Reference:	Nominal stent diameter	Nominal stent length	Total system length
ZNST15x4050	15 mm	40 mm	50 cm	ZNST15x4060	15 mm	40 mm	60 cm
ZNST15x5050	15 mm	50 mm	50 cm	ZNST15x5060	15 mm	50 mm	60 cm
ZNST15x6050	15 mm	60 mm	50 cm	ZNST15x6060	15 mm	60 mm	60 cm
ZNST15x7050	15 mm	70 mm	50 cm	ZNST15x7060	15 mm	70 mm	60 cm
ZNST15x8050	15 mm	80 mm	50 cm	ZNST15x8060	15 mm	80 mm	60 cm
ZNST20x4050	20 mm	40 mm	50 cm	ZNST20x4060	20 mm	40 mm	60 cm
ZNST20x5050	20 mm	50 mm	50 cm	ZNST20x5060	20 mm	50 mm	60 cm
ZNST20x6050	20 mm	60 mm	50 cm	ZNST20x6060	20 mm	60 mm	60 cm
ZNST20x7050	20 mm	70 mm	50 cm	ZNST20x7060	20 mm	70 mm	60 cm
ZNST20x8050	20 mm	80 mm	50 cm	ZNST20x8060	20 mm	80 mm	60 cm
ZNST25x4050	25 mm	40 mm	50 cm	ZNST25x4060	25 mm	40 mm	60 cm
ZNST25x5050	25 mm	50 mm	50 cm	ZNST25x5060	25 mm	50 mm	60 cm
ZNST25x6050	25 mm	60 mm	50 cm	ZNST25x6060	25 mm	60 mm	60 cm
ZNST25x7050	25 mm	70 mm	50 cm	ZNST25x7060	25 mm	70 mm	60 cm
ZNST25x8050	25 mm	80 mm	50 cm	ZNST25x8060	25 mm	80 mm	60 cm
ZNST30x4050	30 mm	40 mm	50 cm	ZNST30x4060	30 mm	40 mm	60 cm
ZNST30x5050	30 mm	50 mm	50 cm	ZNST30x5060	30 mm	50 mm	60 cm
ZNST30x6050	30 mm	60 mm	50 cm	ZNST30x6060	30 mm	60 mm	60 cm
ZNST30x7050	30 mm	70 mm	50 cm	ZNST30x7060	30 mm	70 mm	60 cm
ZNST30x8050	30 mm	80 mm	50 cm	ZNST30x8060	30 mm	80 mm	60 cm

When ordering use Ref. Number, e.g.: ZNST30x8050.

EXTRACTION AND OCCLUSION CATHETER

The double lumen catheter with a balloon is used for the removal of concrements after performing of endoscopic papilotomy and for the control of bile ducts, with an additional central hole allowing rinsing or contrast administration. Catheter made of polyamide, X-ray detectable.

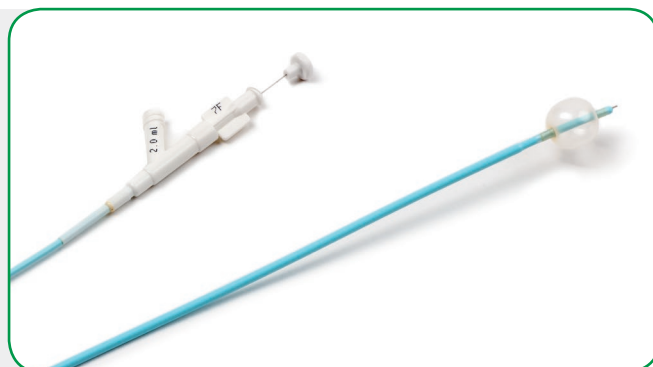

Reference:	Catheter with balloon			Balloon filled with		External diameter
	size	length	central hole	liquid	air	
KDOIE5F170	5F	170 cm	0.6 mm	0.5 ml	1.2 cm ³	9 mm
KDOIE5F200	5F	200 cm	0.6 mm	0.5 ml	1.2 cm ³	9 mm
KDOIE7F170	7F	170 cm	1.0 mm	1.5 ml	2.5 cm ³	14 mm
KDOIE7F200	7F	200 cm	1.0 mm	1.5 ml	2.5 cm ³	14 mm

When ordering use Ref. Number, e.g.: KDOIE7F200.

CATHETER FOR BILE DUCTS' PLASTY

Catheter is used for dilatation of biliary ducts in case of tumour changes or for dilatation of narrowing after surgery. It can be used for dilatation of narrowing of biliary ducts to remove the sludges.



Reference:	Catheter diameter	Catheter length	Balloon diameter	Balloon length	Nominal pressure	Use with guide wire
CBPZ6x2535170	5.5F	170 cm	6 mm	25 mm	6 atm	.035"
CBPZ6x3035170	5.5F	170 cm	6 mm	30 mm	6 atm	.035"
CBPZ8x3035170	5.5F	170 cm	8 mm	30 mm	6 atm	.035"
CBPZ12x4035170	5.5F	170 cm	12 mm	40 mm	6 atm	.035"

When ordering use Ref. Number, e.g.: CBPZ12x4035170.

DILATING CATHETER SOEHENDER type (Percutaneous method)

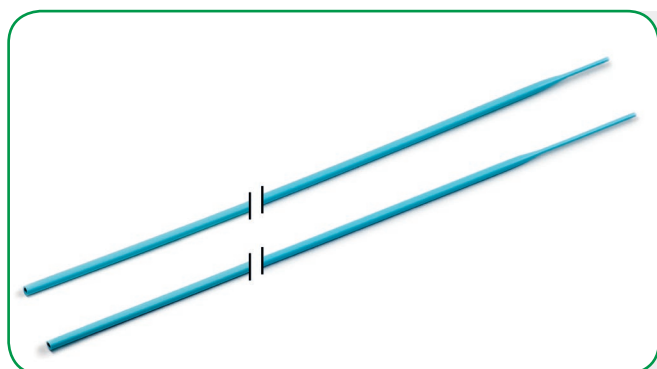

The catheter is more visible in X-ray, without cap, with a thinned distal part of 2 cm and 4 cm in length. Available in sizes ranging from 6F to 12F, with a length of 40cm. Used for dilatation of bile ducts.

Reference:	Catheter size	Catheter length	Use with guide wire	Length of the thinned distal part
KR6F40M2	6F	40 cm	.035"	2 cm
KR6F40M4	6F	40 cm	.035"	4 cm
KR7F40M2	7F	40 cm	.035"	2 cm
KR7F40M4	7F	40 cm	.035"	4 cm
KR8F40M2	8F	40 cm	.035"	2 cm
KR8F40M4	8F	40 cm	.035"	4 cm
KR8,5F40M2	8,5F	40 cm	.035"	2 cm
KR8,5F40M4	8,5F	40 cm	.035"	4 cm
KR9F40M2	9F	40 cm	.035"	2 cm
KR9F40M4	9F	40 cm	.035"	4 cm
KR10F40M2	10F	40 cm	.035"	2 cm
KR10F40M4	10F	40 cm	.035"	4 cm
KR11F40M2	11F	40 cm	.035"	2 cm
KR11F40M4	11F	40 cm	.035"	4 cm
KR11,5F40M2	11,5F	40 cm	.035"	2 cm
KR11,5F40M4	11,5F	40 cm	.035"	4 cm
KR12F40M2	12F	40 cm	.035"	2 cm
KR12F40M4	12F	40 cm	.035"	4 cm

When ordering use Ref. Number, e.g.: KR12F40M2.

DILATING CATHETER Soehender type

The catheter for dilating is made of high quality material (X-ray visible) with a 3 cm cone tip. At the other end the catheter has a luer-lock (mobile) hub. Used for dilatation of bile ducts.

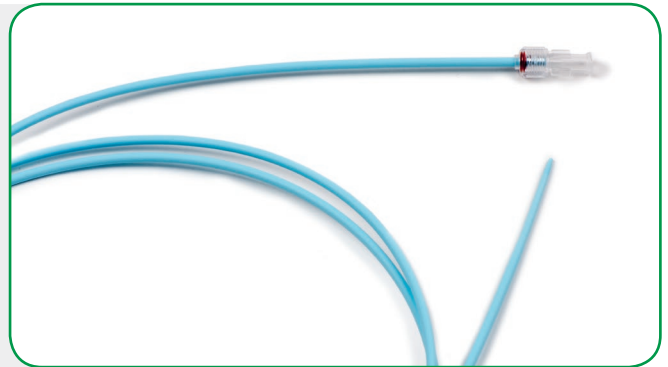

Reference:	Catheter size	Catheter length	Use with guide wire
KR6F	6F	200 cm	.035"
KR7F	7F	200 cm	.035"
KR8F	8F	200 cm	.035"
KR9F	9F	200 cm	.035"
KR10F	10F	200 cm	.035"
KR11.5F	11.5F	200 cm	.035"

When ordering use Ref. Number, e.g.: KR10F.

ORAL BILIARY DUCTS DRAINAGE SET

Set components:

Pigtail, Alfa or Straight catheter
 guide wire /teflon-coated/ diameter .035", 480 cm long
 nasal tube 50 cm long
 two extensions with three - way stopcock

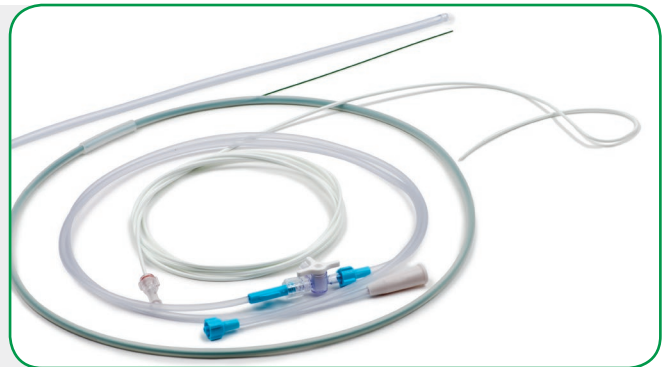

Reference: A type - alpha	Reference: PR type - straight	Reference: PI type - Pigtail	Catheter size / length	Extension with stop-cock length
ZPDDZA5F	ZPDDZPR5F	ZPDDZPI5F	5F / 250 cm	135 cm
ZPDDZA7F	ZPDDZPR7F	ZPDDZPI7F	7F / 250 cm	135 cm

Nasal biliary catheters used for external drainage of biliary ducts, are placed via a duodenoscope, allowing flushing biliary ducts and administering medicaments directly into biliary ducts. Catheters feature Pigtail tips with side holes (Alfa loop option available as well), smooth inner surface facilitates bile flow. They are well visible in X-rays.

When ordering use Ref. Number, e.g.: ZPDDZA5F.

BILIARY PROSTHESIS INSERTION with STRAIGHT type prosthesis

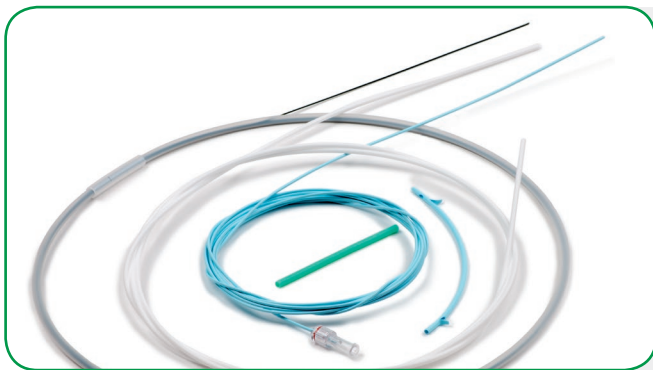

Set components:

leading catheter
pushing catheter
guide wire /teflon coated/
STRAIGHT prosthesis
prosthesis shield

Reference:	STRAIGHT prosthesis size / catch interval	Guide wire diameter / length	Pushing catheter size / length	Leading catheter size / length	Prosthesis shield length
ZPDZ5F	5F / 5,7,9,12,15 cm	.035" / 400 cm	5F / 170 cm	- - -	80 mm
ZPDZ7F	7F / 5,7,9,12,15 cm	.035" / 400 cm	7F / 170 cm	- - -	80 mm
ZPDZ8.5F	8.5F / 5,7,9,12,15 cm	.035" / 400 cm	8.5F / 170 cm	5F/ 320 cm	80 mm
ZPDZ10F	10F / 5,7,9,12,15 cm	.035" / 400 cm	10F / 170 cm	6F/ 320 cm	80 mm
ZPDZ12F	12F / 5,7,9,12,15 cm	.035" / 400 cm	12F / 170 cm	6F/ 320 cm	80 mm
ZPDZ15F	15F / 5,7,9,12,15 cm	.035" / 400 cm	15F / 170 cm	6F/ 320 cm	80 mm

Particular components of the set can be ordered separately.

Biliary ducts internal drainage endoprosthesis in neoplastic and benign stenosis and some cases of cholelithiasis; placed via an endoscope. Endoprosthesis feature:

- elasticity facilitating their introduction and at the same time material hardness preventing them from kinking;
- two "wings" (catch pawls) stabilizing their positioning;
- smooth inner surface facilitating reflux and reducing the possibility of occlusion;
- good visibility in X-rays;
- sets available in configuration with other types of stents: ZIMMON, GEENEN and PIGTAIL.

When ordering use Ref. Number, e.g.: ZPDZ8.5F15 (for catch interval 15 cm).

STRAIGHT type prosthesis

Prosthesis are used for internal biliary ducts drainage in neoplastic and benign stenosis and some cases of cholelithiasis; placed via an endoscope. Prosthesis feature:

- elasticity facilitating their introduction and at the same time material hardness preventing them from kinking;
- two “wings” (catch pawls) stabilizing their positioning;
- smooth inner surface facilitating reflux and reducing the possibility of occlusion;
- good visibility in X-rays;

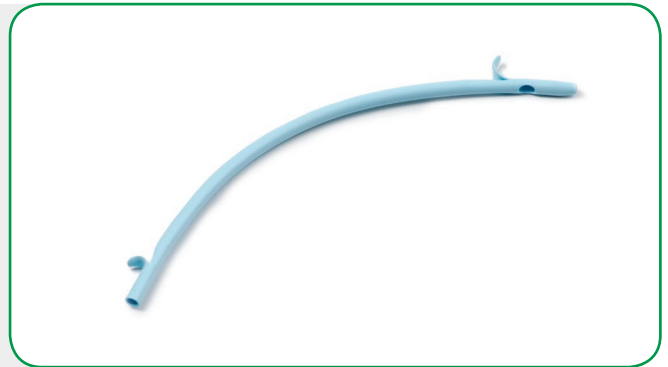

STRAIGHT

Reference:	size	catch interval
E5F	5F	5, 7, 9, 12, 15 cm
E7F	7F	5, 7, 9, 12, 15 cm
E8.5F	8.5F	5, 7, 9, 12, 15 cm
E10F	10F	5, 7, 9, 12, 15 cm
E12F	12F	5, 7, 9, 12, 15 cm
E15F	15F	5, 7, 9, 12, 15 cm

Once prosthesis catalogue number has been selected, include the required distance between the catch pawls.

When ordering use Ref. Number, e.g.: E10F5 (for catch interval 5 cm).

GREENEN type prosthesis

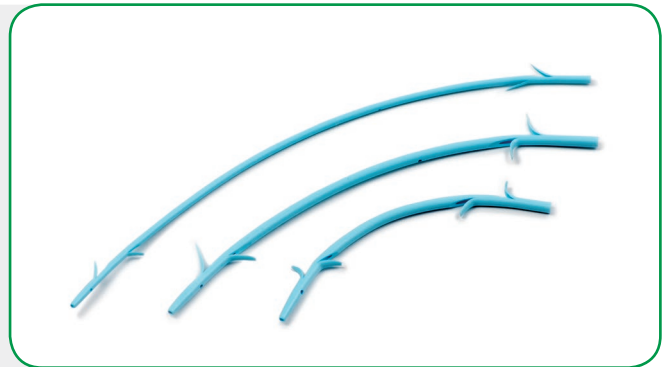

GREENEN

Reference:	size	catch interval
EGE5F	5F	3, 5, 7, 9, 12 cm
EGE7F	7F	3, 5, 7, 9, 12 cm

Once prosthesis catalogue number has been selected, include the required distance between the catch pawls.

When ordering use Ref. Number, e.g.: EGE5F3 (for catch interval 3 cm).

PIGTAIL type prosthesis

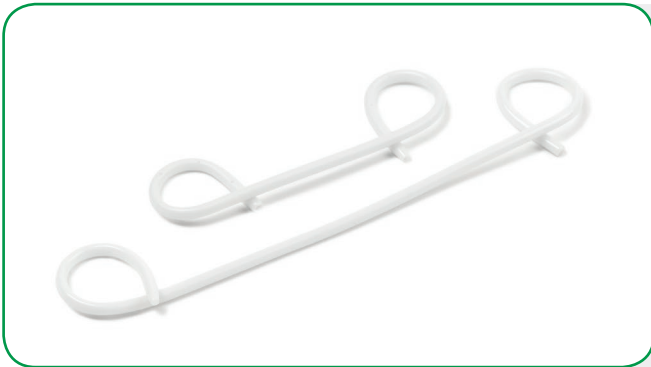

Prostheses are used for internal biliary ducts drainage in neoplastic and benign stenosis and some cases of cholelithiasis; placed via an endoscope.

Prosthesis feature:

- elasticity facilitating their introduction and at the same time material hardness preventing them from kinking;
- smooth inner surface facilitating reflux and reducing the possibility of occlusion;
- good visibility in X-rays;

Reference:	PIGTAIL	
	size	catch interval
EPI7F	7F	5, 7, 10 cm
EPI10F	10F	5, 7, 10 cm

Once prosthesis catalogue number has been selected, include the required distance between the catch loops.

When ordering use Ref. Number, e.g.: EPI10F5 (for catch interval 5 cm).

ZIMMON type prosthesis

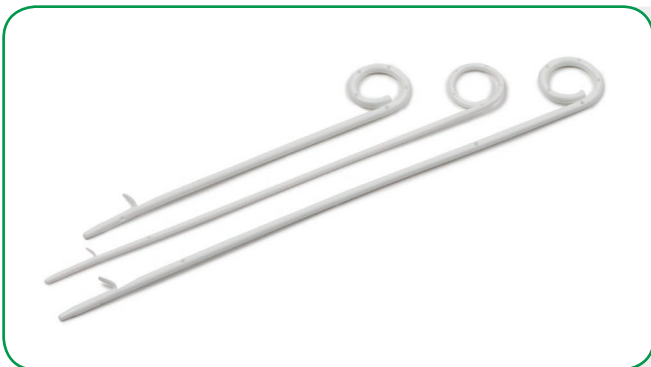

Reference:	ZIMMON	
	size	catch interval
EZI7F	7F	2, 4, 6, 8, 10, 12 cm
EZI10F	10F	2, 4, 6, 8, 10, 12 cm

Once prosthesis catalogue number has been selected, include the required distance between the catch pawl and the loop.

When ordering use Ref. Number, e.g.: EZI10F8 (for catch interval 8 cm).

DUODENAL TUBE

The duodenal tube is used for emptying duodenum in occlusive ileus, acute pancreas inflammation, paralytic ileus, and other clinical situations, depending on physician's discretion. The duodenal tube consists of a one lumen PVC tube. Due to transparency of the tube material aspirated contents observation is possible. The tube's distal tip allows its connection to syringes, adaptors, and other drains. The tube has a closed tip, either rounded or with a central hole. Each tube has four side holes.



Reference:	Tube diameter	Tube length	Hub colour
SD8F125A	8F	125 cm	blue
SD8F125B	8F	125 cm	blue
SD10F125A	10F	125 cm	black
SD10F125B	10F	125 cm	black
SD12F125A	12F	125 cm	white
SD12F125B	12F	125 cm	white
SD14F125A	14F	125 cm	green
SD14F125B	14F	125 cm	green
SD16F125A	16F	125 cm	orange
SD16F125B	16F	125 cm	orange
SD18F125A	18F	125 cm	red
SD18F125B	18F	125 cm	red

When ordering use Ref. Number, e.g.:

SD8F125A - Type A - tip closed and rounded

SD16F125B -Type B - tip with central hole.

GASTRIC TUBE



The gastric tube is used for the quick aspiration of stomach contents or gastric lavage, for continuous emptying of the upper gastrointestinal tract in the case of bowel obstruction, for the administration of enteral nutrition in the case of advanced dysphagia and for the enteral feeding or administration of medicine to premature babies or small infants.

The gastric tube is made of a high class PVC medical grade material, having the required softness and elasticity. Transparency of gastric tube facilitates observation of aspirate. Wthe gastric tube with big lateral side holes enable fast introduction of fluids and gastric contents aspiration.

Reference:	Tube diameter	Tube length	Hub colour
SZ12F75	12F	75 cm	white
SZ12F100	12F	100 cm	white
SZ14F75	14F	75 cm	green
SZ14F100	14F	100 cm	green
SZ16F75	16F	75 cm	orange
SZ16F100	16F	100 cm	orange
SZ18F75	18F	75 cm	red
SZ18F100	18F	100 cm	red
SZ20F75	20F	75 cm	yellow
SZ20F100	20F	100 cm	yellow
SZ22F75	22F	75 cm	blue
SZ22F100	22F	100 cm	blue
SZ24F75	24F	75 cm	blue
SZ24F100	24F	100 cm	blue
SZ26F75	26F	75 cm	blue
SZ26F100	26F	100 cm	blue
SZ28F75	28F	75 cm	blue
SZ28F100	28F	100 cm	blue
SZ30F75	30F	75 cm	blue
SZ30F100	30F	100 cm	blue

When ordering use Ref. Number, e.g.: SZ26F75.

RECTAL TUBE

Rectal tube is used to drain anus lumen and the end-part of the rectum. The rectal tube consists of a single-lumen tube made of PVC. The tube is atraumatic due to specially selected material it is made of.



Reference:	Tube diameter	Tube length	Hub colour
SR18F30A	18F	30 cm	red
SR18F30B	18F	30 cm	red
SR18F40A	18F	40 cm	red
SR18F40B	18F	40 cm	red
SR22F30A	22F	30 cm	blue
SR22F30B	22F	30 cm	blue
SR22F40A	22F	40 cm	blue
SR22F40B	22F	40 cm	blue
SR26F30A	26F	30 cm	blue
SR26F30B	26F	30 cm	blue
SR26F40A	26F	40 cm	blue
SR26F40B	26F	40 cm	blue
SR30F30A	30F	30 cm	blue
SR30F30B	30F	30 cm	blue
SR30F40A	30F	40 cm	blue
SR30F40B	30F	40 cm	blue
SR36F30A	36F	30 cm	blue
SR36F30B	36F	30 cm	blue
SR36F40A	36F	40 cm	blue
SR36F40B	36F	40 cm	blue

When ordering use Ref. Number, e.g.:

SR22F40A - Type A - tip closed and rounded with two side holes

SR18F30B - Type B - tip with central hole and two side holes.

GASTRIC CATHETER



The gastric catheter is used for the quick aspiration of stomach contents or gastric lavage, for continuous emptying of the upper gastrointestinal tract in the case of bowel obstruction, for the administration of the enteral nutrition in the case of advanced dysphagia and for enteral feeding or administration of medicine to premature babies or small infants.

The gastric catheter is made of a high class PVC medical grade material, having the required softness and elasticity. The transparency of gastric catheter facilitates observation of aspirate. The distal tip (hub) of gastric catheter enables their connection to syringes, adapters and various drains. The central opened end and lateral side hole enable fast introduction of fluids and gastric contents aspiration.

Reference:	Tube diameter	Tube length	Hub colour
KZ12F150	12F	150 cm	white
KZ14F150	14F	150 cm	green
KZ16F150	16F	150 cm	orange
KZ18F150	18F	150 cm	red
KZ20F150	20F	150 cm	yellow
KZ22F150	22F	150 cm	blue
KZ24F150	24F	150 cm	blue
KZ26F150	26F	150 cm	blue
KZ28F150	28F	150 cm	blue
KZ30F150	30F	150 cm	blue
KZ32F150	32F	150 cm	blue
KZ34F150	34F	150 cm	blue
KZ36F150	36F	150 cm	blue

When ordering use Ref. Number, e.g.: KZ28F150.

INTESTINAL STENTS CATHETER

Triple channel catheters



Catheter diameter 22F, 300 cm long
balloon volume 15 ml (gas)

Reference:	Balloon volume
K3KSJ22F300	15 ml

When ordering use Ref. Number, e.g.: K3KSJ22F300.